

STANDARDS OVERVIEW

SIEMON GUIDELINES TO INDUSTRY STANDARDS

Since the first release of the Commercial Building Telecommunications Cabling Standard (ANSI/TIA/EIA 568 in 1991), the volume of standards information available to the end-user community has increased substantially. As a result, The Siemon Company has focused efforts on educating our customer's on the importance of generic, standards-based components and system requirements. The following information has been condensed from a compilation of relevant national and international telecommunications standards and provides a reference to the most commonly used information. Because our active involvement in standards development provides us with advance information on emerging standards requirements for both the premises cabling and the applications that the cabling is intended to support, we've also included a sneak preview of upcoming standards, bulletins, and addendums.

SECTION CONTENTS

OVERVIEW	13.2
Horizontal Cabling System Structure	13.3
Backbone Cabling System Structure.....	13.4
Work Area	13.5
OPEN OFFICE (TSB75)	13.6
Horizontal Distances of Copper Links (Open Office)	13.7
Horizontal Distances of Optical Fiber Links (Long Work Area Cables).....	13.7
TELECOMMUNICATIONS CLOSET	13.8
TWISTED PAIR (BALANCED) CABLING	13.9
UTP Telecommunications Outlet/Connector	13.10
Fully Shielded Telecommunications Outlet/Connector	13.10
UTP Connecting Hardware vs. Cable Next Performance	13.10
UTP Link Performance Marking and Identification	13.10
ScTP Cabling	13.11
Fully Shielded Cabling	13.11
FIELD TESTING (TSB67)	13.12
OPTICAL FIBER CABLING	13.13
TSB72	13.14

SECTION CONTENTS

ADDENDA TO '568-A AND FUTURE WORK

TIA/EIA-568-A-1 13.15
 TIA/EIA-568-A-2 13.15
 TIA/EIA-568-A-3 13.15
 Proposed TIA/EIA-568-A-4 13.16
 TIA/EIA-568-A-5 13.16
 TIA/EIA TSB95 13.16
 PN-3193 13.16
 Future Specifications 13.17
 Cabling Specification Cross-Reference Chart 13.18

COMPARISON OF '568-A AND PENDING PN-3727 VS. '11801 FIBER CABLING PERFORMANCE SPECIFICATIONS . . . 13.20

CABLES, MEDIA AND WIRING

Horizontal UTP Cable 13.21
 Hybrid and Bundled Cables 13.21
 UTP Patch Cords and Cross-Connect Jumpers 13.21
 Backbone UTP Cable 13.21
 Modular Wiring Reference 13.22
 Modular Plug Pair Configurations 13.23
 Straight Through or Reversed? 13.23
 How to Read a Modular Cord 13.23
 Recommended Cabling Practices 13.24
 UTP Connector Terminations 13.24
 Application-Specific Pair Assignments for the 100 Ω Cabling 13.24
 Recommended Color-Coding Scheme 13.24

UTP CABLING INSTALLATION PRACTICES 13.24

ANSI/TIA/EIA-569-A 13.25

Horizontal 13.26
 Backbone 13.26
 Work Area 13.27
 Telecommunications Closets 13.28
 Equipment Room 13.29
 Main Terminal Space 13.29
 Entrance Facility 13.29
 Miscellaneous 13.29

AN OVERVIEW OF CABLING STANDARDS

ANSI/TIA/EIA-568-A and ISO/IEC 11801

The latest editions of the ANSI/TIA/EIA-568-A('568-A) and ISO/IEC 11801 cabling standards were both published in 1995. The following overview provides some of the requirements and recommendations of each standard including differences between them.

ANSI/TIA/EIA-568-A

Commercial Building Telecommunications Cabling Standard
The Telecommunications Industry Association (TIA) TR41.8.1 Working Group on telecommunications cabling published the ANSI/TIA/EIA-568-A standard in 1995.

ISO/IEC 11801

Information Technology – Generic Cabling for Customer Premises
The International Organization for Standardization (ISO) SC 25/WG 3 Working Group on telecommunications cabling published the ISO/IEC 11801 standard in 1995.

Following are highlights of the '568-A standard and related Telecommunication Systems Bulletins (TSBs) with notes on differences in terminology and technical requirements with respect to ISO/IEC 11801. For clarity and consistency, '568-A based terminology is used in the following overview.

Purpose

- To specify a generic voice and data telecommunications cabling system that will support a multi-product, multi-vendor environment.
- To provide direction for the design of telecommunications equipment and cabling products intended to serve commercial enterprises.
- To enable the planning and installation of a structured cabling system for commercial buildings that is capable of supporting the diverse telecommunications needs of building occupants.
- To establish performance and technical criteria for various types of cable and connecting hardware and for cabling system design and installation.

Scope

- Specifications are intended for telecommunications installations that are "office oriented".
- Requirements are for a structured cabling system with a usable life in excess of 10 years.
- Specifications addressed:
 - Recognized Media - Cable and Connecting Hardware
 - Performance
 - Topology
 - Cabling Distance
 - Installation Practices
 - User Interfaces
 - Channel Performance

Cabling Elements:

- Horizontal Cabling:
 - Horizontal Cross-connect (HC)
 - Horizontal Cable
 - Transition Point (optional)
 - Consolidation Point (optional)
 - Telecommunications-Outlet/Connector (TO)
- Backbone Cabling:
 - Main Cross-connect (MC)
 - Interbuilding Backbone Cable
 - Intermediate Cross-connect (IC)
 - Intrabuilding Backbone Cable
- Work Area (WA)
- Telecommunications Closet (TC)
- Equipment Room (ER)
- Entrance Facility (EF)
- Administration*

* Although administration is addressed to a limited extent, the governing specification on telecommunications administration is ANSI/TIA/EIA-606.

ANNEX INFORMATION

The following Normative and Informative Annexes are provided in ANSI/TIA/EIA-568-A:



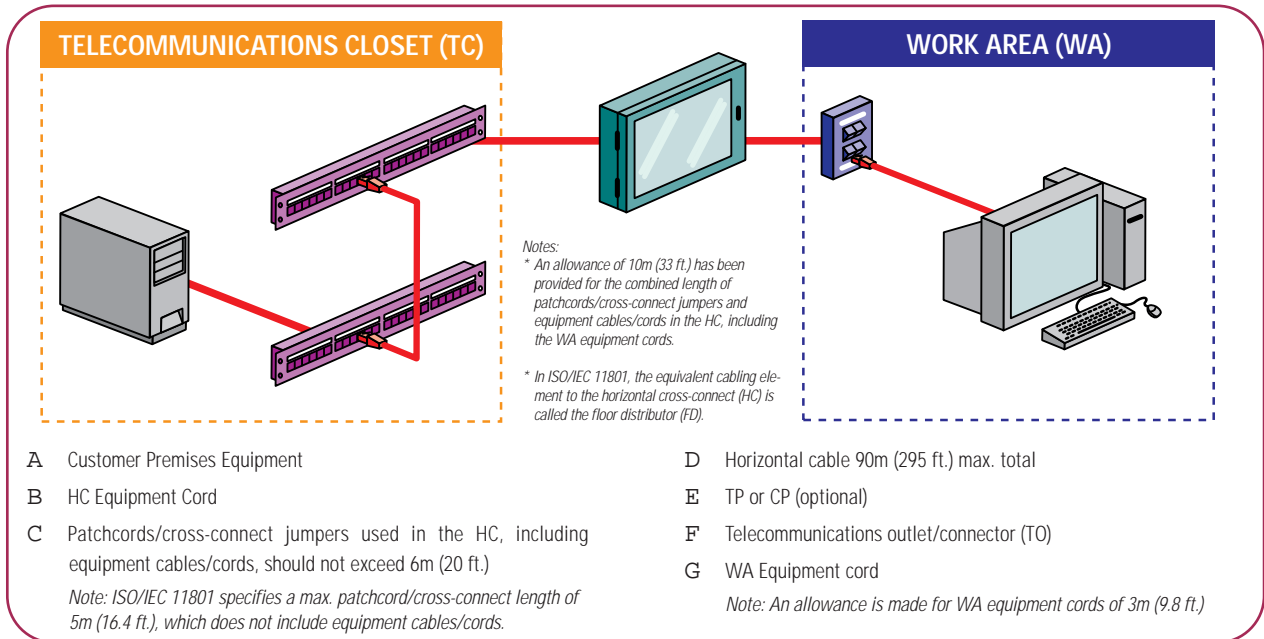

- | | |
|-----------------------------------------------------------------------------------------------|---------------------------------------------------------------------|
| A. Reliability Testing of Connecting Hardware used for 100 Ω UTP cabling (Normative). | E. Unshielded Twisted-pair (UTP) Channel Performance (Informative). |
| B. Transmission Testing of Connecting Hardware used for 100 Ω UTP cabling (Normative). | F. Migration Paths for Optical Fiber Connections (Informative). |
| C. Transmission Testing of Connecting Hardware for 150 Ω STP-A Cables (Normative). | G. Other Cable Specifications (Informative). |
| D. Shared Sheath Guidelines for Multi-pair UTP Cables (Informative). | H. Optical Fiber Link Performance Testing (Informative). |
| | I. Bandwidth considerations (Informative). |
| | J. Bibliography (Informative). |

HORIZONTAL CABLING SYSTEM STRUCTURE

The horizontal cabling system extends from the telecommunications outlet in the work area to the horizontal cross-connect in the telecommunications closet. It includes the telecommunications outlet, an optional consolidation point or transition point connector, horizontal cable, and the mechanical terminations and patch cords (or jumpers) that comprise the horizontal cross-connect.



Some points specified for the horizontal cabling subsystem include:

- Application specific components shall not be installed as part of the horizontal cabling. When needed, they must be placed external to the telecommunications outlet or horizontal cross-connect (eg. splitters, baluns).
- The proximity of horizontal cabling to sources of electromagnetic interference (EMI) shall be taken into account. 
- Recognized Horizontal Cables:
 - 4-pair 100 Ω unshielded twisted-pair 
 - 2-fiber (duplex) 62.5/125 μm or multimode optical fiber (note: 50/125 μm multimode fiber will be allowed in '568-B) 
 - 2-pair 150 Ω STP-A 

Note: In addition, two alternate horizontal cabling types allowed by ISO/IEC 11801 are 120 Ω unshielded twisted-pair and 50/125 μm multimode optical fiber.
- Multipair and multi-unit cables are allowed, provided that they satisfy the hybrid/bundled cable requirements of TIA/EIA-568-A-3 (see page 13.15).
- Grounding must conform to applicable building codes, as well as ANSI/TIA/EIA-607.
- A minimum of two telecommunications outlets are required for each individual work area.
 - First outlet: 100 Ω twisted-pair
 - Second outlet: 100 Ω twisted-pair, or 150 Ω STP-A, or 62.5/125 μm multimode fiber.

- One transition point (TP) is allowed between different forms of the same cable type (i.e. where undercarpet cable connects to round cable).
Note: The definition provided for a "transition point" in ISO/IEC 11801 is broader than '568-A. It includes transitions to under carpet cabling as well as consolidation point connections. (See Open Office Cabling, page 13.6.)
- 50 Ω coax cabling is recognized by '568-A but is not recommended for new cabling installations.
- Additional outlets may be provided. These outlets are in addition to and may not replace the minimum requirements of the standard.
- Bridged taps and splices are not allowed for copper-based horizontal cabling. (Splices are allowed for fiber.)
Note: In ISO/IEC 11801, the equivalent cabling element to the horizontal cross-connect (HC) is called the floor distributor (FD).

Topology

The horizontal cabling shall be configured in a star topology; each work area outlet is connected to a horizontal cross-connect (HC) in a telecommunications closet (TC).

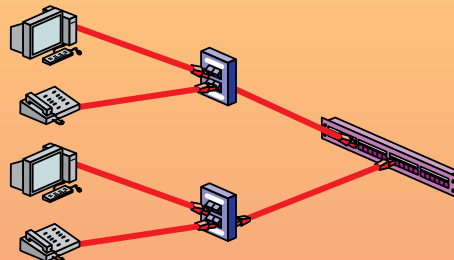

BACKBONE CABLING SYSTEM STRUCTURE

The backbone cabling system provides interconnections between telecommunications closets, equipment rooms, and entrance facilities. It includes backbone cables, intermediate and main cross-connects, mechanical terminations, and patch cords or jumpers used for backbone-to-backbone cross-connections. The backbone also extends between buildings in a campus environment.

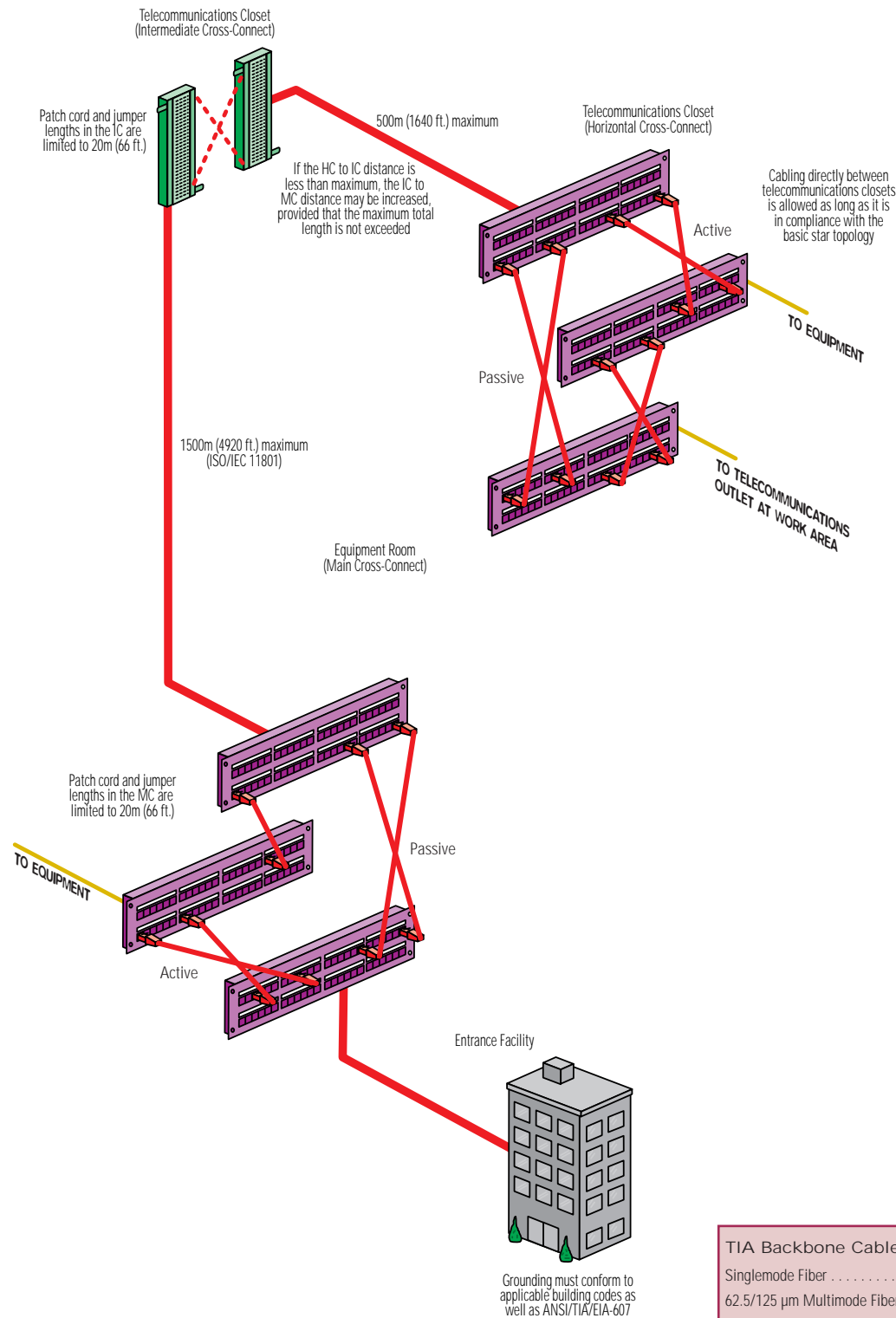

TIA Backbone Cable Distances (MC to HC)	
Singlemode Fiber	3000m (9840 ft.)
62.5/125 μm Multimode Fiber	2000m (6560 ft.)
UTP Copper Applications < 5 MHz	800m (2625 ft.)

Some points specified for the backbone cabling subsystem include:

- Equipment connections to backbone cabling should be made with cable lengths of 30m (98 ft.) or less.
- The backbone cabling shall be configured in a star topology. Each horizontal cross-connect is connected directly to a main cross-connect or to an intermediate cross-connect, then to a main cross-connect.
- The backbone is limited to no more than two hierarchical levels of cross-connects (main and intermediate). No more than one cross-connect may exist between a main and a horizontal cross-connect and no more than three cross-connects may exist between any two horizontal cross-connects.
- A total maximum backbone distance of 90m (295 ft.) is specified for high bandwidth capability over copper. This distance is for uninterrupted backbone runs. (No intermediate cross-connect).
- The distance between the terminations in the entrance facility and the main cross-connect shall be documented and should be made available to the service provider.

- Recognized media may be used individually or in combination, as required by the installation. Quantity of pairs and fibers needed in individual backbone runs depends on the area served. Recognized backbone cables are:

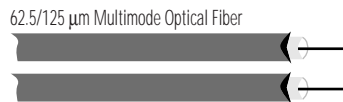

Note: 50/125 μm multimode fiber will be recognized in TIA-568-B.

- Multipair cable is allowed, provided that it satisfies the power sum crosstalk requirements.
- The proximity of backbone cabling to sources of electromagnetic interference (EMI) shall be taken into account.
- Cross-connects for different cable types must be located in the same facilities
- Bridged taps are not allowed.

Notes: In ISO/IEC 11801, the equivalent cabling elements to the main cross-connect (MC) and intermediate cross-connect (IC) are called the campus distributor (CD) and building distributor (BD) respectively.

In addition to those listed, two alternate backbone cabling types allowed by ISO/IEC are 120 Ω twisted-pair and 50/125 μm multimode optical fiber.

50 Ω coaxial cabling is recognized by '568-A, but is not recommended for new installations.

WORK AREA

The telecommunications outlet serves as the work area interface to the cabling system. Work area equipment and cables used to connect to the telecommunications outlet are outside the scope of '568-A and ISO/IEC 11801, but are expected to be specified in the next edition of these standards.

Adapters and application-specific devices (such as baluns) shall be external to the telecommunications outlet.

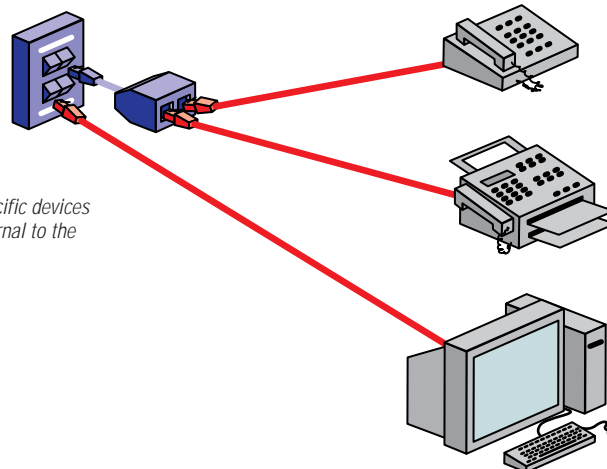

Some specifications related to work area cabling include:

- Equipment cords are assumed to have the same performance as patch cords of the same type and category.
- When used, adapters are assumed to be compatible with the transmission capabilities of the equipment to which they connect.
- Horizontal cable lengths are specified with the assumption that a maximum cable length of 3m (10 ft.) is used for equipment cords in the work area.

Note: For establishing maximum horizontal link distances, a combined maximum length of 10m (33 ft.) is allowed for patch cables (or jumpers) and for equipment cables in the work area and the telecommunications closet.

TSB75

OPEN OFFICE CABLING:

Additional specifications for horizontal cabling in areas with moveable furniture and partitions have been introduced in TIA/EIA TSB75. Horizontal cabling methodologies are specified for "open office" environments by means of multi-user telecommunications outlet assemblies and consolidation points. These methodologies are intended to provide increased flexibility and economy for installations with open office work spaces that require frequent reconfiguration.

This is an example of Open Office Implementation using a MuTOA: Multi-user Telecommunications Outlet Assembly

MuTOA: A telecommunications outlet scheme intended to serve multiple work areas in an open office environment.

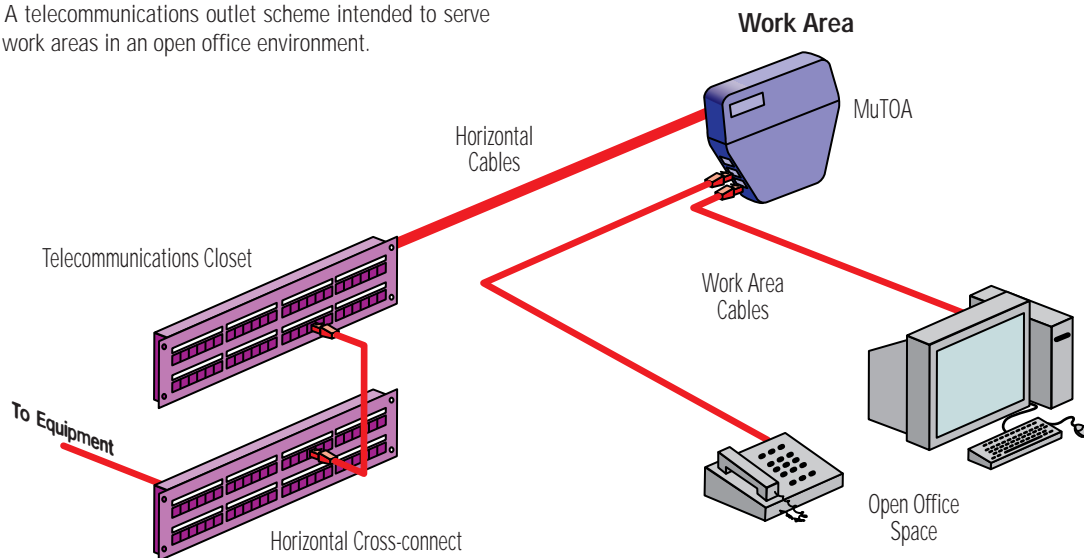

This is an example of Open Office Implementation Using a Consolidation Point Connector

Consolidation Point: An interconnection scheme that connects horizontal cables from building pathways to cables that extend to TOs through open office pathways.

Note: A consolidation point (CP) is referred to in '11801 as a transition point (TP).

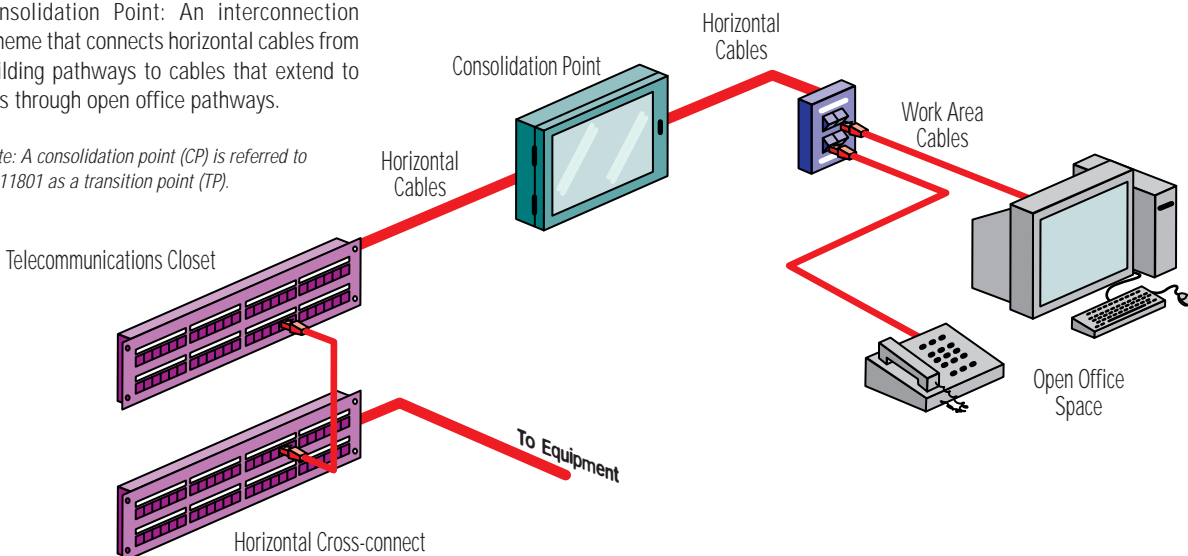

HORIZONTAL DISTANCES OF COPPER LINKS (OPEN OFFICE)

Copper work area cables connected to a MuTOA, shall meet the requirements of '568-A (sec. 10.5 and 11.5). The maximum length of copper work area cables shall be determined according to:

$$C = (102 - H) / 1.2$$

$$W = C - 7 (<20 \text{ m})$$

Where:

C is the combined length of the work area cable, equipment cable, and patch cord (m).

W is the length of the work area cable (m).

H is the length of the horizontal cable (m).

The above equations assume that there is a total of 7m (23 ft.) of patch and equipment cables in the equipment closet. Table 1 shows the application of these formulae. The length of work area cables shall not exceed 20m (66 ft.). The MuTOA shall be marked with the maximum allowable work area cable length.

Length of Horizontal Cable	Maximum Length of Work Area Cable	Maximum Combined Length of Work Area Cables, Patch Cords, and Equipment Cable
H m (ft.)	W m (ft.)	C m (ft.)
90 (295)		10 (33)
85 (279)	7 (23)	14 (46)
80 (262)		18 (59)
75 (246)	15 (49)	22 (72)
70 (230)		27 (89)

Table 1 — Maximum Length of Work Area Cables

HORIZONTAL DISTANCES OF OPTICAL FIBER LINKS (LONG WORK AREAS CABLES)

For optical fiber cables, any length combination of horizontal cables and work area cables is acceptable as long as the total combined length of the horizontal channel does not exceed 100m (328 ft.).

When deploying a centralized fiber cabling topology, the general guidelines of TSB72 shall be followed.

Advantages and Features

- It is preferable to use MuTOAs only when the entire length of the work area cord is accessible to facilitate tracing and to prevent erroneous disconnection. Up to 20 meters (66 ft.) of work area cable are allowed.
- MuTOAs are subject to the same interface requirements specified for each media type.
- Consolidation point (transition point) requirements are performance based. There is no physical interface requirement for the CP except those required to meet functional requirements.
- Implementations using either MuTOAs or CPs are subject to the same end-to-end performance requirements.
- Consolidation points have the advantage that they deliver dedicated TOs to individual work areas and do not require provisions for extended cord lengths.

TELECOMMUNICATIONS CLOSET

Telecommunications closets are generally considered to be floor serving facilities for horizontal cable distribution. They may also be used for intermediate and main cross-connects.

Some specifications related to the telecommunications closet:

- Closets shall be designed and equipped in accordance with ANSI/TIA/EIA-569-A.
- Cable stress from tight bends, cable ties, staples, and tension should be avoided by well-designed cable management.
- Only standards-compliant connecting hardware shall be used.
- Cables and cords used for active equipment connections are outside the scope of the standard (10m total allowed for patch cords, equipment cables, and work area cables for each link).
- Application-specific electrical components shall not be installed as part of the horizontal cabling.
- Horizontal cable terminations shall not be used to administer cabling system changes. Instead, jumpers patch cords, or equipment cords are required for re-configuring cabling connections.

The two types of schemes used to connect cabling subsystems to each other and to equipment are known as interconnections and cross-connections.

Note: A "cross-connect" (a.k.a. distributor) is a facility, whereas a "cross-connection" is a connection scheme. Cross-connections are typically used to provide a means of configuring individual port connections between the cabling and equipment with multiport outputs (i.e., 25-pair connectors). Interconnections may be used with equipment that has individual output ports. A cross-connect facility (a.k.a. distributor) may house interconnections, cross-connections, or both.

Cross-connection:

A connection scheme using patch cords or jumpers that attach to connecting hardware on each end.

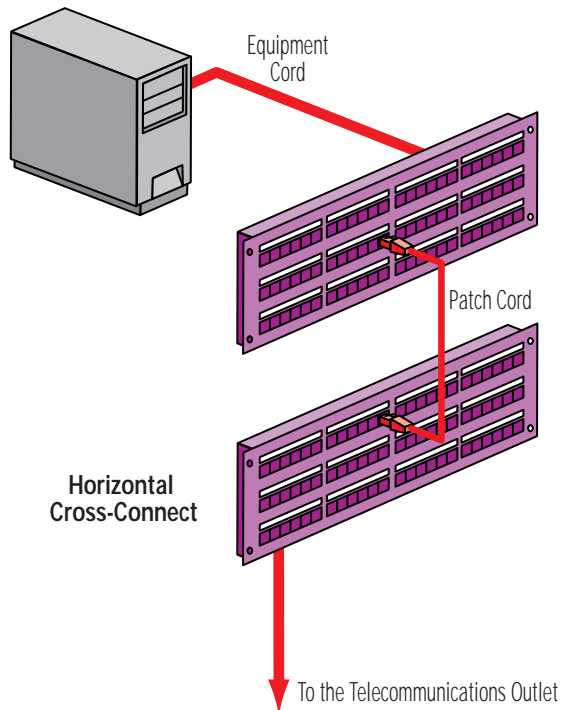





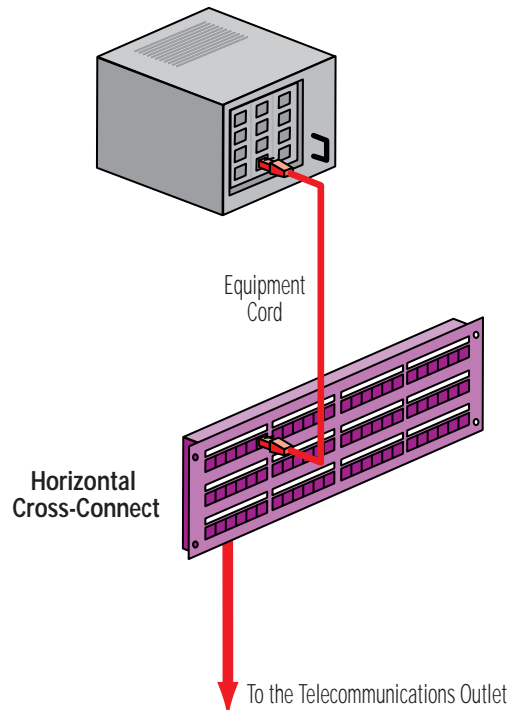





Interconnection:

A connection scheme that provides for direct connections to building cabling from equipment without a patch cord.



TWISTED-PAIR (BALANCED) CABLING

The six categories of transmission performance specified for cables, connecting hardware and links are*:

Designation	Transmission Characteristics	Description
	Transmission characteristics are specified up to 16 MHz.	Meets applicable category 3 and class C requirements of ISO/IEC 11801 (including amendments A.1 & A.2), ANSI/TIA/EIA-568-A (including addenda A-1, A-2 & A-3) and TSB67. Requirements are specified to an upper frequency limit of 16 MHz.
	Transmission characteristics are specified up to 20 MHz.	Meets applicable category 4 requirements of ISO/IEC 11801 (including amendments A.1 & A.2), ANSI/TIA/EIA-568-A (including addenda A-1, A-2 & A-3) and TSB67. Requirements are specified to an upper frequency limit of 20 MHz. This classification is a superset of  .
	Transmission characteristics are specified up to 100 MHz.	Meets applicable category 5 and class D requirements of ISO/IEC 11801 (including amendments A.1 & A.2), ANSI/TIA/EIA-568-A (including addenda A-1, A-2 & A-3), TSB67 and draft TSB95. Requirements are specified to an upper frequency limit of 100 MHz. This classification is a superset of  .
<hr/>		
	Transmission characteristics are specified up to 100 MHz.	Performs to category 5e* and additional class D requirements of draft amendment 3 of ISO/IEC 11801, and draft addendum 5 to ANSI/TIA/EIA-568-A. Requirements are specified to an upper frequency limit of 100 MHz. This classification is a superset of  .
	Transmission characteristics will be specified up to 250 MHz.	Performs to category 6* and class E requirements under development by ISO/IEC and TIA. Requirements are expected to be specified to an upper frequency limit of at least 250 MHz. This classification is a superset of  .
	Transmission characteristics will be specified up to 600 MHz.	Performs to category 7* and class F requirements under development by ISO/IEC. Requirements are expected to be specified to an upper frequency limit of at least 600 MHz. This classification is an electrical superset of  .

* Category 5e, 6 and 7 industry standards are currently under development

Notes:

It is strongly recommended that new category 5 cabling installations be specified to satisfy the minimum requirements of category 5e and it is expected that '568-A-5 will emerge as the new de facto minimum standard for category 5 cabling.

Terminology and classifications specified in ISO/IEC 11801 for cabling links differ slightly from TIA categories (See page 13.18 in this catalog). UTP categories 1 and 2 are not specified.

Components and installation practices are subject to all applicable building and safety codes that may be in effect.

The Siemon Company offers component and link performance guides based on '568-A and '11801 standards. Contact our sales office for a free copy.

UTP TELECOMMUNICATIONS OUTLET/CONNECTOR:

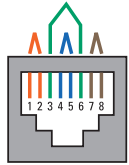

- 8-position modular jack per IEC 603-7 ('568-A states that all 4 pairs must be connected).
- Pin/pair assignment: T568A (US federal government publication FIPS PUB 174 recognizes designation T568A only).
- Optional assignment to accommodate certain systems: T568B.
- Durability rating 750 mating cycles minimum.



FULLY SHIELDED TELECOMMUNICATIONS OUTLET/CONNECTOR:

- Entirely new interface design to support class F cabling.
- Will require a new wiring pin/pair assignment.
- Transmission measurement methods for category 7 are under study.
- Durability rating 1000 mating cycles minimum.

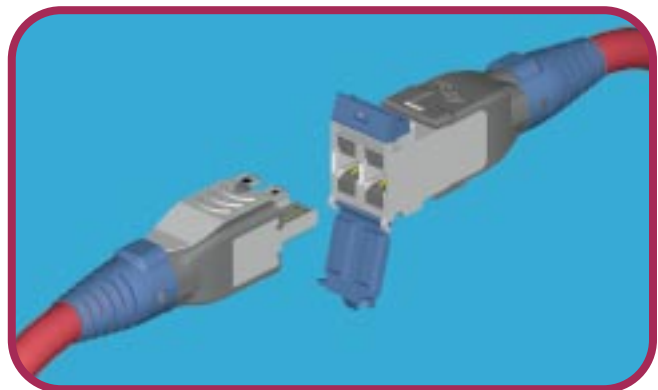

13.10

UTP CONNECTING HARDWARE VS. CABLE NEXT PERFORMANCE

- Specifications cover all types of connectors used in the cabling system including the telecommunications outlet/connector.
- Does not cover work area adapters, baluns, protection, MAUs, filters, or other application-specific devices.
- Temperature range - 10°C (14°F) to 60°C (140°F).
- Outlets shall be securely mounted. Outlet boxes with unterminated cables must be covered and marked.
- Transmission requirements are much more severe than cable of a corresponding category. (See graph)
- Performance markings should be provided to show the applicable transmission category and should be visible during installation (for example ) in addition to safety markings.
- Installed connectors shall be protected from physical damage and moisture.

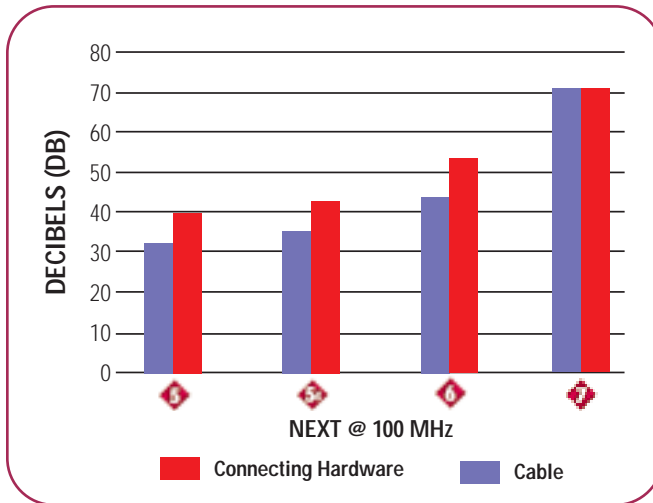

UTP LINK PERFORMANCE MARKING AND IDENTIFICATION

- Link category marking should be clearly visible on both ends (component markings are not sufficient).
- Labeling, markings, and color-coding shall be provided in accordance with ANSI/TIA/EIA-606.

ScTP CABLING

As a result of the latest release of ANSI/TIA/EIA-568-A and the international ISO/IEC 11801 documents, many telecommunications groups now recognize the presence of an overall shield over four twisted-pairs; a media hybrid termed Screened Twisted-Pair or ScTP cabling.



STP-A Cable:

- Color-coding:
 - Pair 1 = White/Blue – Blue
 - Pair 2 = White/Orange – Orange
 - Pair 3 = White/Green – Green
 - Pair 4 = White Brown – Brown
- 0.51mm (24 AWG) 100 Ω 4-pair enclosed by a foil shield.
- A copper conductor drain wire of .040mm (26 AWG) or larger shall be provided.
- Should be marked "100 Ω ScTP", in addition to any safety markings required by local or national codes.
- Same mechanical and transmission requirements apply to backbone and horizontal cables.
- Additional performance requirements, including surface transfer impedance, is specified the TIA PN-3193 draft entitled, "Technical Specifications for 100 Ω Screened Twisted-Pair Cabling".

ScTP Connectors:

- Interface and pair assignments same as IEC 603-7 ('568-A states that all 4 pairs must be connected).
- Additional transfer impedance and shield mating interface requirements specified in the TIA PN-3193 draft entitled, "Technical Specifications for 100 Ω Screened Twisted-Pair Cabling".

ScTP Patch Cords:

- Specifications call for 26 AWG (7 strands @ 0.15mm) or 24 AWG (7 strands @ 0.20mm) stranded conductors.
- Allows for an overall shield.
- Less severe attenuation than horizontal cable.

ScTP Installation Practices:

- Shield shall be bonded at both ends at the "Telecommunication Grounding Busbar".
- The difference between the two grounds shall be no more than 1.0 V RMS.

FULLY SHIELDED CABLING

Fully shielded cabling requirements are under development by ISO. Cable and connector specification will extend to at least 600 MHz and are intended to support the pending class F cabling requirements.



Fully Shielded Cable:

- Color-coding:
 - Pair 1 = White/Blue – Blue
 - Pair 2 = White/Orange – Orange
 - Pair 3 = White/Green – Green
 - Pair 4 = White Brown – Brown
- Four 0.51mm (24 AWG) or larger 100 Ω twisted-pairs each enclosed by an individual foil shield with an overall shield provided over the four-pairs.
- Mechanical and transmission requirements are under development by ISO.

Fully Shielded Connectors:

- Interface and pair assignments are under development by ISO and will be entirely different from the T568A and T568B assignments.
- Mechanical and transmission requirements are under development by ISO.

Fully Shielded Patch Cables:

- Mechanical and transmission requirements are under development by ISO.

Fully Shielded Installation Practices:

- Installation Practices are under development by ISO.

TSB67

Transmission Performance Specifications for Field Testing of UTP Cabling Systems

This bulletin provides users with the opportunity to use comprehensive test methods to validate the transmission performance characteristics of installed UTP cabling systems. The categories of UTP cabling systems in this bulletin also correspond with the UTP cabling categories of ANSI/TIA/EIA-568-A. Additional transmission performance and applicable field test requirements are referenced in TSB95, '568-A-5 and proposed amendment 3 to '11801 (PDAM 3).

Horizontal Channel

Performance Specified in TIA/EIA TSB67

- TIA/EIA TSB95 (category 5)
- TIA/EIA-568-A-5 (category 5e)
- ISO/IEC 11801 Amendment 3

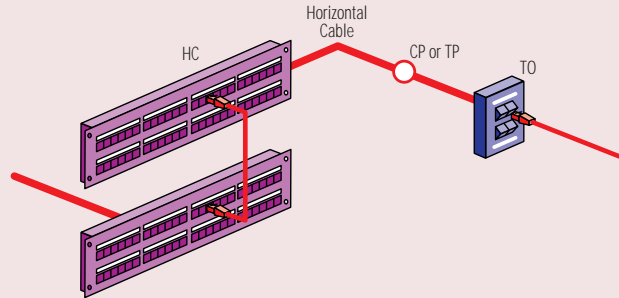

Transmission Performance Comparison @ 100 MHz

for Category 5/Class D and Category 5e/Class D (PDAM 3) Channels

Cabling Type	Channel Attenuation (dB)	Channel NEXT (dB)	Channel ELFEXT (dB)	Channel Return Loss (dB)	Channel ACR (dB)
Category 5 (@100 MHz)	24.0	27.1	17.0	8.0	3.1
Category 5e (@ 100 MHz)	24.0	30.1	17.4	10.0	6.1
Class D (PDAM 3) (@ 100 MHz)	24.0	27.1	17.0	10.0	3.1

Numbers in parenthesis are calculated based on using 5 meters of additional flexible cables that meet Class D ISO/IEC 11801.

Basic Link Test Configuration

Performance Specified in TIA/EIA TSB67

- TIA/EIA TSB95 (category 5)
- TIA/EIA-568-A-5 (category 5e)
- ISO/IEC 11801 Amendment 3

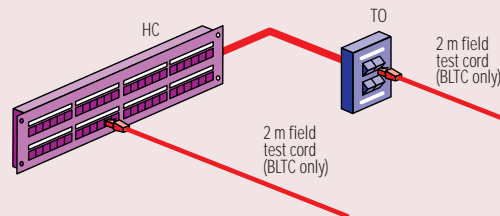

Transmission Performance Comparison

for Category 5/Category 5e Basic Links and Class D/Class D (PDAM 3) Permanent Links

Cabling Type	Basic/Permanent Link Attenuation (dB)	Basic/Permanent Link NEXT (dB)	Basic/Permanent Link ELFEXT (dB)	Basic/Permanent Link Return Loss (dB)	Basic/Permanent Link ACR (dB)
Category 5 (@100 MHz)	21.6	29.3	17.0	10.1	7.7
Category 5e (@ 100 MHz)	21.6 (94m)	32.3	20.0	12.0	10.7 (94m)
Class D (PDAM 3) (@ 100 MHz)	20.6 (90m)	29.3	19.6	12.0	8.7 (90m)

Class D attenuation values are calculated based on 90 meters horizontal cable plus two connectors (no flexible cord contribution) that meet ISO/IEC 11801. Class D NEXT values are based on voltage summation of the near-end connector and horizontal cable.

Some points specified for TSB67 transmission field testing for UTP cabling systems

- UTP cabling systems are comprised of cables and connecting hardware specified in TIA/EIA-568-A.
- Required test parameters include wire-map, length, attenuation, and crosstalk.
- Two levels of pass or fail are indicated, depending on measured margin compared to minimum specifications. Testing of NEXT is required in both directions.
- Level II equipment meets the most stringent requirements for TSB67 measurement accuracy. Level IIe equipment will be required to verify category 5e and PDAM 3 performance.
- Requirements are intended for performance validation and are provided in addition to '568-A requirements on components and installation practices.

OPTICAL FIBER CABLING

These specifications on optical fiber cabling consist of one recognized cable type for horizontal subsystems and two cable types for backbone subsystems:

Horizontal – 62.5/125 μm multimode (two fibers per outlet).

Backbone – 62.5/125 μm multimode or singlemode.

It is likely that the next publication of '568-B will also recognize 50/125 μm multimode optical fiber in both the horizontal and backbone.

All optical fiber components and installation practices shall meet applicable building and safety codes.

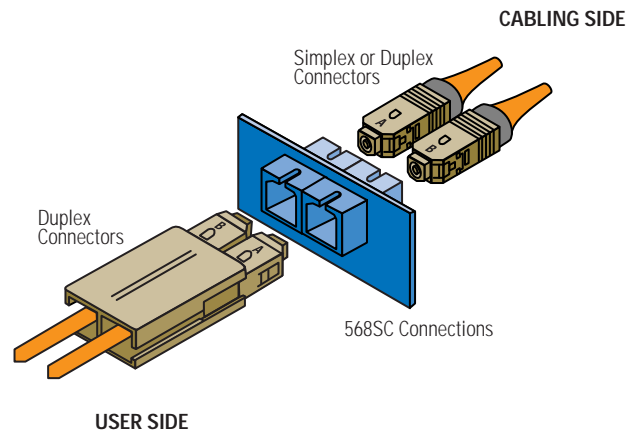

Optical Fiber Patch Cords:

- Shall be a two-fiber (duplex) indoor cable of the same type as the cables to which they connect.
- Shall allow for easy connection and reconnection and ensure that polarity is maintained (568SC configuration required).
- Shall perform a pair-wise cross-over of fiber positions A and B. (If provided in simplex form, one connector shall be identified as "A" and the other "B".)

Installation of Optical Fiber Connecting Hardware:

- Connectors shall be protected from physical damage and moisture.
- Capacity for 12 or more fibers per rack space [44.5mm (1.75 in.)] should be provided.
- Optical fiber connecting hardware shall be installed:
 - To provide well organized installation with cable management.
 - In accordance with manufacturers' guidelines.

Optical Fiber Cabling Installation:

- A minimum of 1m (3.28 ft.) of two-fiber cable (or two buffered fibers) shall be accessible for termination purposes.
- Testing is recommended to assure correct polarity and acceptable link performance. Informative annex H of '568-A is provided for recommended optical fiber link performance testing criteria.

Optical Fiber Connections:

- Recommended adapter and connector is designated as 568SC (a duplex SC that is capable of simplex operation).
- ST connectors are allowed, where an installed base exists.
- In cross-connects, a 568SC duplex connector is specified.
- For the work area side of the telecommunications outlet, a simplex or duplex SC connector is specified.
- 568SC patch cords are required.
- Telecommunications outlet/connector boxes shall be securely mounted at planned locations.
- The two positions in a duplex connector are referred to as "position A" and "position B".
- The telecommunications outlet/connector box shall have:
 - The ability to secure optical fibers.
 - Cable management means to assure a minimum bend radius of 30mm (1.18 in.) and should have slack storage capability.
 - Provisions for terminating a minimum of two optical fibers into a 568SC adapter.
- Identification of fiber types:
 - Multimode connectors and adapters shall be identified with the color beige.
 - Singlemode connectors and adapters shall be identified with the color blue.
- 568SC connectors are rated for a minimum of 500 mating cycles.
- The 568SC adapter performs a pair-wise cross-over between position A and position B of two mated connectors
- Optical fiber runs intended for future connections shall be stored in a telecommunications outlet/connector box.

TSB72**Centralized Optical Fiber Cabling Guidelines**

This Telecommunications Systems Bulletin (TSB) provides the user with the flexibility of designing an optical fiber cabling system for centralized electronics typically in single tenant buildings. It contains information and guidelines for centralized optical fiber cabling.

Typical schematic for centralized optical fiber cabling using an interconnection.

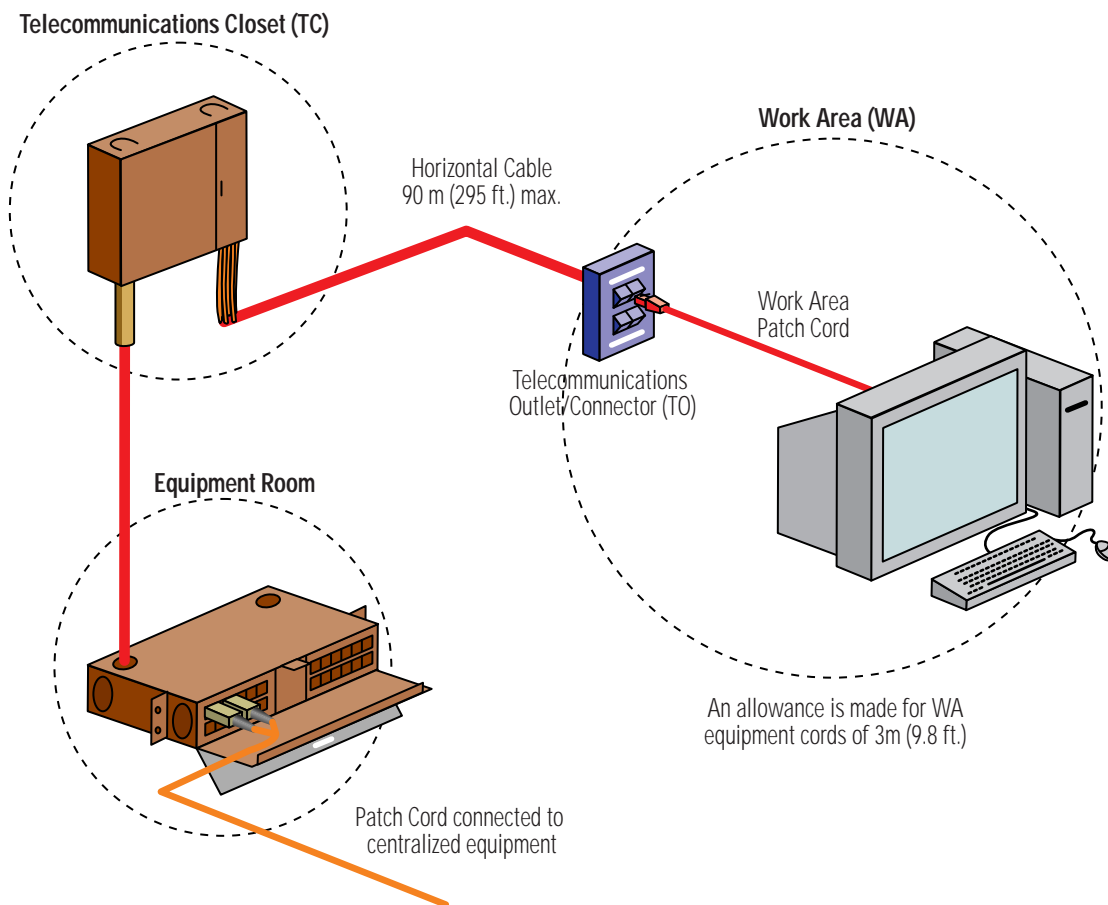
**Some points specified in TSB-72 for a centralized optical fiber cabling system include:**

- Intended for single-tenant users who desire centralized vs. distributed electronics.
- Implementation allows cables to be spliced or interconnected at the telecommunications closet such that cables can be routed to a centralized distributor for total cable lengths of 300m (984 ft.) or less, including patch cords or jumpers.
- Allows for migration from an interconnection or splice to a cross-connection scheme that can also support distributed electronics.
- Pull-through implementations are allowed when total length between the telecommunications outlet/connector and centralized cross-connect is 90m (295 ft.) or less.
- Connecting hardware required to:
 - join fibers by re-mateable connectors or splices,
 - connectors shall be 568SC interface,
 - provide for simplex or duplex connection of optical fibers,
 - provide means of circuit identification,
 - allow for addition and removal of optical fibers.

Note: Some multimode fiber implementations may be limited to an operating range of 220m to support 1000BASE-SX.

TIA/EIA-568-A-1**Propagation Delay and Delay Skew**

This addendum to '568-A describes propagation delay and delay skew requirements for all '568-A compliant 4-pair 100 Ω cables. Propagation delay and delay skew requirements of multipair cables are subject to additional study.

Propagation delay is equivalent to the amount of time that passes between when a signal is transmitted and when it is received at the other end of a cabling channel. Delay skew is the difference between the pair with the least delay and the pair with the most delay. Transmission errors that are associated with excessive delay and delay skew include increased jitter and bit error rates.

The maximum propagation delay skew requirement for 4-pair 100 Ω cables is frequency dependent and is specified by the following equation:

$$\text{delay (ns/100m)} \leq 534 + \frac{36}{\sqrt{f_{\text{MHz}}}}$$

Cable delay skew shall not exceed 45 ns/100m between 1 MHz and the highest referenced frequency for a given category.

It is anticipated that the requirements of '568-A-1 will also be applicable to pending category 6 cable propagation delay and delay skew specifications while more stringent performance criteria will be specified for pending category 7 cables.

TIA/EIA-568-A-2**Corrections and Additions to TIA/EIA-568-A**

This addendum to '568-A provides modifications and corrections to the content of '568-A as a result of advances in telecommunications research and development. Revisions are as follows:

1. Centralized optical fiber cabling is referenced in two locations (5.2.1 and 7.4.1) as an alternative to the optical cross-connection located in the telecommunications closet when deploying 62.5/125 μm optical fiber cable in the horizontal. TIA/EIA TSB72 Centralized Optical Fiber Cabling Guidelines are also referenced.
2. The ANSI/ICEA reference in section 10.2.3 was updated to ANSI/ICEA S-90-661-1994 for specifying the physical and mechanical requirements of '568-A recognized cables.
3. Additional text was incorporated into section 10.4.3.4 specifying that the connecting hardware used for 100 Ω UTP cabling shall not result in or contain any transposed (e.g. transposition of pairs 2 or 3) or reversed (also called tip/ring reversals) pairs. It is further noted that applications requiring transposed or reversed pairs shall utilize adapters, work area or equipment cords to swap pairs.
4. A reference to the TSB67 field test methodologies is added to section 10.6.4.
5. The 568SC optical fiber connector off axial pull strength requirement was decreased from 22 N (5 lbf) to 19.4 N (4.4 lbf).
6. Globally, the word "polarization" was replaced with "polarity".
7. The initial contact resistance specified in Annex A for connecting hardware was increased from 1 m Ω to 2.5 m Ω and the contact resistance measurement method was re-written to be more user-friendly.
8. A provision for common mode terminations for testing connecting hardware NEXT loss and return loss was incorporated into Annex B. This revision accommodates telecommunications networking implementations that may employ common mode terminations in the active equipment.

13.15

TIA/EIA-568-A-3**Addendum 3 to TIA/EIA-568-A**

As a result of the demand for open office architecture and the need to support multiple telecommunications applications in a shared sheath, this addendum to '568-A addresses revised performance specifications for hybrid cables. '568-A-3 also introduces a new term called "**bundled cables**" to describe 4-pair cable assemblies that are not covered by an overall sheath (as specified for hybrid cables), but by any generic binding method such as "speed-wrap" or "cable-ties"

The new hybrid and bundled cable requirements state that power sum NEXT loss between all non-fiber cable types within the cable shall be 3 dB better than the specified pair-to-pair NEXT loss for each cable type. See figure 1.

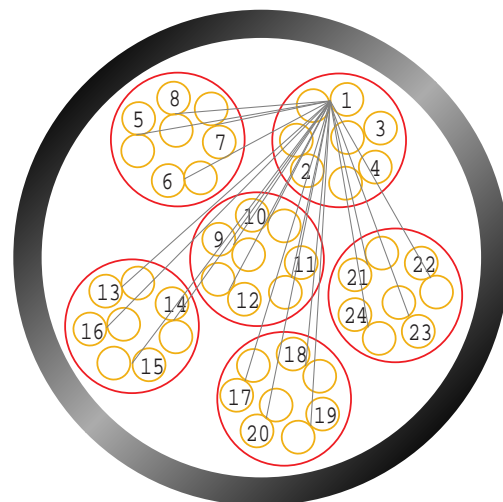
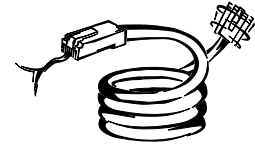

Figure 1: Pair-to-Pair measurements required to calculate power sum NEXT for pair 1 of a 24-pair cable.

PN-4349 Proposed Addendum 4 to '568-A (TIA/EIA-568-A-4)

Transmission Performance of Patch Cord Assemblies

The efforts of the TIA PN-2948 connecting hardware task group have yielded a NEXT loss test method for the NEXT loss qualification of modular patch cords. The method utilizes a "de-embedding" technique to subtract out the NEXT loss contribution of the test fixtures and results in a method that is non-destructive and suitable for use in a production environment. Performance limits are based upon a calculation of the stranded modular cord and mated plug contribution.



TIA/EIA-568-A-5

Additional Transmission Performance Specifications for 4-Pair 100Ω Enhanced Category 5 Cabling, Addendum 5 to '568-A



Proposed '568-A specifies enhanced category 5 (category 5e) performance requirements. These requirements are recommended for new category 5 cabling installations and are expected to become the de facto minimum standard for category 5 cabling. This document addresses the minimum equal level far-end crosstalk (ELFEXT) and return loss requirements necessary to support developments in applications technology and defines the minimum performance needed for a worst case four-connector channel to support applications that utilize full-duplex transmission schemes, such as Gigabit Ethernet. To ensure additional crosstalk headroom for robust applications support, this document also specifies power sum performance requirements for category 5e cables and cabling.

Proposed addendum 'A-5 is a normative document and, unlike TSB-95, it provides mandatory requirements, not recommendations.

TIA/EIA TSB95

Additional Transmission Performance Guidelines for 100Ω 4-Pair Category 5 Cabling



Proposed TSB95 outlines minimum recommendations for the new channel parameters of return loss and equal level far-end crosstalk (ELFEXT). These return loss and ELFEXT recommendations are specified to ensure the support of Gigabit Ethernet over installed or "legacy" category 5 cabling and were derived from worst case performance of channels with only two connection points. The two-connector channel topology is consistent with the IEEE committee's assumption that cabling used to support Gigabit Ethernet systems will most likely utilize an interconnect instead of a cross-connect field and will not include a consolidation or transition point connection. Existing installed category 5 cabling should be verified to ensure that performance meets the minimum recommendations of this document. Channel configurations with three or four connectors that meet the specified ELFEXT and return loss recommendations will also support Gigabit Ethernet. Because the specifications of this document are applicable for the qualification of existing, installed cabling only, they are not recommended to be used as the minimum performance criteria for new category 5 cabling.

Originally balloted as an addendum, this document will be published as a Technical Systems Bulletin (TSB). This document is informative in nature and does not contain mandatory or "shall" requirements.

13.16

PN-3193

Technical Specifications for 100 Ω Screened Twisted-Pair Cabling

PN-3193 is an interim standard that supplements TIA-568-A and ISO/IEC 11801 screened twisted-pair cabling specifications by describing additional technical requirements on the outlet interface, shield effectiveness, installation practices, and performance relative to ScTP links and components.

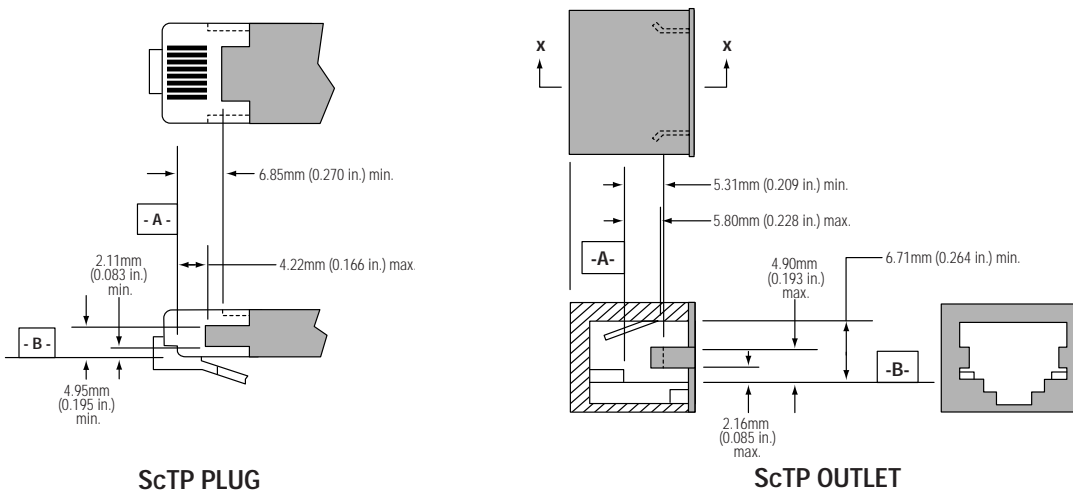

FUTURE SPECIFICATIONS:

Now that ANSI/TIA/EIA-568-A and ISO/IEC 11801 have reached maturity, cabling standards groups are focusing their efforts on the development of next generation cabling specifications and the fulfillment of technical issues that have surfaced as a result of their ongoing developmental efforts. Some of the draft specifications and guidelines that are being investigated by national or international standards groups for future publications or next editions of '568-A and '11801 are outlined below.

ISO/IEC JTC 1/SC 25 N 487

CLASS D

Proposed Draft Amendment 3 to ISO/IEC 11801 (PDAM 3)

The performance specifications in ISO PDAM 3 provide new requirements for return loss and ELFEXT loss to compliment the existing ISO class D requirements. The PDAM 3 specified return loss and ELFEXT loss requirements are in harmony with the values proposed in '568-A-5, however, PDAM 3 does not specify additional NEXT loss margin over and above the existing class D requirements. PDAM 3 also includes propagation delay and delay skew requirements for channels and permanent links that are in harmony with the requirements of TIA/EIA-568-A-1.

The requirements of proposed amendment 3 to ISO/IEC 11801 are normative and this document will become the governing international standard for new Class D cabling installations.

Category 6/Class E



Proposed category 6/class E standards describe a new performance range for unshielded and screened twisted-pair cabling. Category 6/class E is intended to specify the best performance that UTP and ScTP cabling solutions can be designed to deliver. It is anticipated that category 6/class E will be specified in the frequency range of at least 1-250 MHz. For category 6/class E, the 8-position modular jack interface will be mandatory at the work area. Category 6/class E will be backward compatible meaning that applications running on lower categories/classes will also be supported. If different category/class components are to be mixed with category 6/class E components, the combination shall meet the transmission requirements of the lowest performing category/class component.

TIA, ISO, CENELEC, and others are collaborating closely on the development of category 6 and class E standards and their proposed requirements are very much in harmony.

Category 7/Class F



Proposed category 7/class F describes a new performance range for fully shielded (i.e., overall shield and individually shielded pairs) twisted-pair cabling. It is anticipated that category 7/class F will be specified in the frequency range of 1-600 MHz. Even though these requirements will be supported by an entirely new modular interface design (i.e., plug and socket), category 7/class F will be backward compatible meaning that applications running on lower categories/classes will also be supported. If different category 7/class E components are to be mixed with category 7/class E, the combination shall at least meet the transmission requirements of the lowest performing category/class component.

It is interesting to note that TIA is not actively developing a standard for category 7 and will most likely harmonize with the class F requirements put forth by ISO.

CABLING SPECIFICATION CROSS-REFERENCE CHART (ANSI/TIA/EIA-568-A AND ISO/IEC 11801)

The following chart provides a side-by-side comparison that highlights many of the fundamental similarities and differences between ANSI/TIA/EIA-568-A and ISO/IEC 11801.

ANSI/TIA/EIA-568-A (and addenda)

Commercial Building Telecommunications Cabling Standard

ISO/IEC 11801 (and amendments)

Generic Cabling for Customer Premises

Terminology

<i>Cross-connect (a facility enabling the termination of cable elements and their connection by patch cord or jumper).</i>	<i>Distributor (a facility enabling the termination of cable elements and their connection by patch cord or jumper).</i>
<i>MC (Main Cross-connect)</i>	<i>CD (Campus Distributor)</i>
<i>IC (Intermediate Cross-connect)</i>	<i>BD (Building Distributor)</i>
<i>HC (Horizontal Cross-connect)</i>	<i>FD (Floor Distributor)</i>
<i>TO (Telecommunications Outlet/connector)</i>	<i>TO (Telecommunications Outlet)</i>
<i>TP (Transition Point) A location in the horizontal cabling where flat undercarpet cable connects to round cable.</i>	<i>TP (Transition Point) A location in the horizontal cabling where flat undercarpet cable connects to round cable or where horizontal cables are consolidated near the outlets.</i>
<i>CP (Consolidation Point) An interconnection scheme that connects horizontal cables that extend from building pathways to horizontal cables that extend into work area pathways.</i>	<i>See TP (Transition Point).</i>
<i>Interbuilding Backbone</i>	<i>Campus Backbone</i>
<i>Intrabuilding Backbone</i>	<i>Building Backbone</i>

Horizontal Media Choices

<i>4-pair 100 Ω unshielded twisted-pair</i>	<i>*4-pair (or 2-pair) *100 Ω (or 120 Ω) balanced cable</i>
<i>Two fiber, 62.5/125 μm optical fiber</i>	<i>*62.5/125 μm (or 50/125 μm) optical fiber</i>
<i>2-pair, 150 Ω shielded twisted-pair</i>	<i>2-pair, 150 Ω shielded twisted-pair</i>
<i>50 Ω coaxial cable (Expected to be eliminated next edition.)</i>	

**indicates preferred media choices.*

Backbone Media Choices

<i>100 Ω unshielded twisted-pair</i>	<i>100 Ω (or 120 Ω) balanced cable</i>
<i>62.5/125 μm optical fiber (50/125 μm to be added)</i>	<i>62.5/125 μm or 50/125 μm optical fiber</i>
<i>Singlemode optical fiber</i>	<i>Singlemode optical fiber</i>
<i>150 Ω shielded twisted-pair</i>	<i>150 Ω shielded twisted-pair</i>
<i>50 Ω coaxial cable (Expected to be eliminated next edition.)</i>	

Bend Radius

<i>Horizontal ≥ 4 times cable O.D.</i>	<i>Horizontal ≥ 4 times cable O.D.</i>
<i>Backbone ≥ 10 times cable O.D.</i>	<i>Backbone ≥ 6 times cable O.D.</i>
<i>No specifications while pulling cables.</i>	<i>≥ 8 times cable O.D. while pulling cables.</i>

Engineering Approach

<i>Not applicable. Field testing for verification only.</i>	<i>Link performance determines compliance.</i>
-------------------------------------------------------------	------------------------------------------------

ANSI/TIA/EIA-568-A (and addenda)
Commercial Building Telecommunications Cabling Standard

ISO/IEC 11801 (and amendments)
Generic Cabling for Customer Premises

Design Approach

Design constraints, component specifications, and installation methods determine compliance.

Design constraints, component specifications, and installation methods determine compliance.

Connector Termination

All pairs shall be terminated at the outlet.

Partial termination at the 100 Ω or 120 Ω outlet is permitted.

Pair untwist shall not exceed 13 mm (0.5 in) for category 5 cables and shall not exceed 25 mm (1.0 in) for category 4 cables. for category 4 cables.

Pair untwist should not exceed 13mm (0.5 in.) for category 5 cables and should not exceed 25mm (1.0 in.)

Categories of Cabling Performance

Category 3 is specified to 16 MHz.

Class C is specified to 16 MHz.

Category 4 is specified to 20 MHz.

No comparable class is provided for category 4.

Category 5 and 5e is specified to 100 MHz.

Class D is specified to 100 MHz.

An Optical Class is also specified.

Category 6 to be specified to 250 MHz.

Class E to be specified to 250 MHz.

Category 7 to be specified to 600 MHz.

Class F to be specified to 600 MHz.

Note: For TIA standards, the term "category" is used to specify both components and cabling performance. For ISO/IEC and CENELEC standards, the term "category" is used to describe component performance (i.e., cable and connecting hardware). The term "class" is used to describe cabling (i.e., link and channel performance).

Performance Specification

Stranded Cable Attenuation = 20% margin over solid requirements.

Stranded Cable Attenuation = 50% margin over solid requirements.

Curve fit evaluation of impedance performance allowed.

Curve fit evaluation of impedance performance not allowed.

Hybrid requirements are applicable to the total number of (non-fiber) units within a cable. (Power sum margin + 3dB over pair-to-pair limit.)

Hybrid requirements based upon adjacent non-fiber units within a cable.

COMPARISON OF '568-A AND PENDING PN-3727 VERSUS '11801 FIBER CABLING PERFORMANCE SPECIFICATIONS

'568-A and pending PN-3727

'11801

Horizontal Link Specifications

$Link_{Atten} \leq 2.0 \text{ dB at } 850 \text{ nm and } 1300 \text{ nm}$

$Link_{Atten} \leq 2.5 \text{ dB at } 850 \text{ nm}$

$Link_{Atten} \leq 2.2 \text{ dB at } 1300 \text{ nm}$

Backbone Link Specifications

Calculated from Component Contributions as follows:
 $Link_{Atten} \leq Cable_{Atten} + Connector_{Atten} + Splice_{Atten}$

Calculated from Component Contributions as follows:
 $Link_{Atten} \leq Cable_{Atten} + Connector_{Atten} + Splice_{Atten}$

Optical Fiber Component Specifications

$Connector_{Atten} \leq 0.75 \text{ dB}$

$Connector_{Atten} \leq 0.5 \text{ dB}$

$Splice_{Atten} \leq 0.3 \text{ dB}$

$Splice_{Atten} \leq 0.3 \text{ dB}$

$Cable_{Atten} \leq 3.75 \text{ dB/km at } 850 \text{ nm for } 62.5/125 \mu\text{m}$

$Cable_{Atten} \leq 3.5 \text{ dB/km at } 850 \text{ nm for } 62.5/125 \mu\text{m and } 50/125 \mu\text{m}$

$Cable_{Atten} \leq 1.5 \text{ dB/km at } 1300 \text{ nm for } 62.5/125 \mu\text{m}$

$Cable_{Atten} \leq 1.0 \text{ dB/km at } 1300 \text{ nm for } 62.5/125 \mu\text{m and } 50/125 \mu\text{m}$

$Cable_{Atten}$ TBD for 50/125 μm

$Cable_{Atten} \leq 0.5 \text{ dB/km for singlemode outside plant cable}$

$Cable_{Atten} \leq 1.0 \text{ dB/km for singlemode (no differentiation between inside and outside plant cables)}$

$Cable_{Atten} \leq 1.0 \text{ dB/km for singlemode inside plant cable}$

Optical Fiber Modal Bandwidth

Bandwidth $\geq 160 \text{ MHz-Km at } 850 \text{ nm for } 62.5/125 \mu\text{m}$

Bandwidth $\geq 200 \text{ MHz-Km at } 850 \text{ nm for } 62.5/125 \mu\text{m and } 50/125 \mu\text{m}$

Bandwidth $\geq 500 \text{ MHz-Km at } 1300 \text{ nm for } 62.5/125 \mu\text{m}$

Bandwidth $\geq 500 \text{ MHz-Km at } 1300 \text{ nm for } 62.5/125 \mu\text{m and } 50/125 \mu\text{m}$

HORIZONTAL UTP CABLE

- Solid 4-pair 0.51mm (24 AWG) specified [0.64mm (22 AWG) solid also allowed]. An overall shield (ScTP) is optional.
- Performance marking should be provided to show the applicable performance category. These markings do not replace safety markings.
- Color-coding:



*Tracers are optional for cables with twist rates of less than 38mm (1.5 in.).

HYBRID AND BUNDLED CABLES

Hybrid/Bundled Cables:

- Hybrid/bundled cables that contain multiple units of recognized horizontal copper cables are subject to additional NEXT loss requirements between cable units. These requirements assure a minimum of 3 dB additional power sum crosstalk isolation between applications that may operate on adjacent binder groups.
- All detailed specifications for the individual cable units used in the hybrid assembly still apply.

UTP PATCH CORDS AND CROSS-CONNECT JUMPERS

- Patch cords must use stranded cable for adequate flex-life.
- Stranded cables must meet the minimum performance requirements for horizontal cable except that 20 percent more attenuation is allowed by '568-A and 50 percent more attenuation is allowed by '11801.
- Color-code for cross-connect jumpers: One conductor white, the other a visibly distinct color such as red or blue.
- Performance markings should be provided to show the applicable transmission category in addition to safety markings.
- Insulated O.D. of stranded wires should be 0.8mm (0.032 in.) to 1mm (0.039 in.) to fit into a modular plug.
- Production performance specifications for plug cord assemblies are being developed as PN-4349.

- Color Codes for Stranded, 100 Ω UTP Patch Cord:

Option 1

- white/blue–blue
- white/orange–orange
- white/green–green
- white/brown–brown

- PAIR 1
- PAIR 2
- PAIR 3
- PAIR 4

Option 2

- green–red
- black–yellow
- blue–orange
- brown–slate

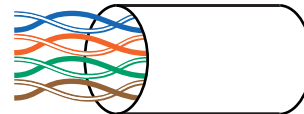

Note: Because of their identical pair groupings, patch cords terminated with either T568A or T568B pair assignments may be used interchangeably, provided that both ends are terminated with the same pin/pair scheme.

BACKBONE UTP CABLE

- Performance markings should be provided to show the applicable performance category. These markings do not replace safety markings.
- Services with incompatible signal levels should be partitioned into separate binder groups. Guidelines for shared sheaths are provided in annex D of '568-A.
- Transmission requirements are equivalent to horizontal cables except that NEXT loss performance is based on power-sum rather than worst-pair characterization to allow for multiple disturbing signals (of the same type) in the same sheath.
- Note: Tip conductors have colored insulation that corresponds to that of the binder group. Ring conductors have colored insulation that corresponds to that of the pair.
- Backbone UTP cables consist of solid 0.51 mm (24 AWG) cables that contain more than four pairs (typically multiples of 25-pairs are used). An overall shield is optional.
- Color-coding (specified by reference to ICEA: see chart to right).

Color-coding (specified by reference to ICEA)

TIP		RING	
white/blue	pair 1	blue/white	pair 1
white/orange	pair 2	orange/white	pair 2
white/green	pair 3	green/white	pair 3
white/brown	pair 4	brown/white	pair 4
white/slate	pair 5	slate/white	pair 5
red/blue	pair 6	blue/red	pair 6
red/orange	pair 7	orange/red	pair 7
red/green	pair 8	green/red	pair 8
red/brown	pair 9	brown/red	pair 9
red/slate	pair 10	slate/red	pair 10
black/blue	pair 11	blue/black	pair 11
black/orange	pair 12	orange/black	pair 12
black/green	pair 13	green/black	pair 13
black/brown	pair 14	brown/black	pair 14
black/slate	pair 15	slate/black	pair 15
yellow/blue	pair 16	blue/yellow	pair 16
yellow/orange	pair 17	orange/yellow	pair 17
yellow/green	pair 18	green/yellow	pair 18
yellow/brown	pair 19	brown/yellow	pair 19
yellow/slate	pair 20	slate/yellow	pair 20
violet/blue	pair 21	blue/violet	pair 21
violet/orange	pair 22	orange/violet	pair 22
violet/green	pair 23	green/violet	pair 23
violet/brown	pair 24	brown/violet	pair 24
violet/slate	pair 25	slate/violet	pair 25

MODULAR WIRING REFERENCE

Modular Jack Styles:

There are four basic modular jack styles. The 8-position modular outlets are commonly and incorrectly referred to as "RJ45". The 6-position modular jack is commonly referred to as RJ11. Using these terms can sometimes lead to confusion since the RJ designations actually refer to very specific wiring configurations called Universal Service Ordering Codes (USOC). The designation 'RJ' means Registered Jack. Each of these basic jack styles can be wired for different RJ configurations. For example, the 6-position jack can be wired as an RJ11C (1-pair), RJ14C (2-pair), or RJ25C (3-pair) configuration. An 8-position jack can be wired

for configurations such as RJ61C (4-pair) and RJ48C. The keyed 8-position jack can be wired for RJ45S, RJ46S, and RJ47S. The fourth modular jack style is a modified version of the 6-position jack (modified modular jack or MMJ). It was designed by Digital Equipment Corporation® (DEC) along with the modified modular plug (MMP) to eliminate the possibility of connecting DEC data equipment to voice lines and vice versa.

Note: The Siemon Company has developed a guide to modular hardware pin/pair assignments. Contact our sales office for a free copy.

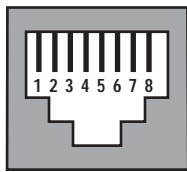

8-position

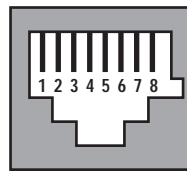

8-position keyed

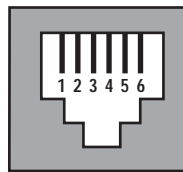

6-position

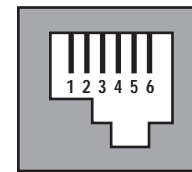

6-position modified

Common Outlet Configurations:

Two wiring schemes have been adopted. They are nearly identical except that pairs two and three are reversed. T568A is the preferred scheme because it is compatible with 1 or 2-pair USOC systems. Either configuration can be used for Integrated Services Digital Network (ISDN) and high speed data applications. Transmission categories 3, 4, 5, 5e, and 6 are only applicable to this type of pair grouping.

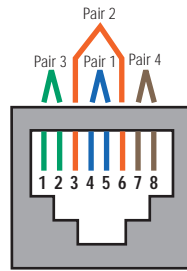

T568A

Pair ID	PIN #
T1	5
R1	4
T2	3
R2	6
T3	1
R3	2
T4	7
R4	8

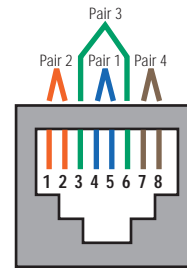

T568B

Pair ID	PIN #
T1	5
R1	4
T2	1
R2	2
T3	3
R3	6
T4	7
R4	8

USOC wiring is available for 1-, 2-, 3-, or 4-pair systems. Pair 1 occupies the center conductors, pair 2 occupies the next two contacts out, etc. One advantage to this scheme is that a 6-position plug configured with 1, 2, or 3 pairs can be inserted into an 8-position jack and still maintain pair continuity. A note of warning though, pins 1 and 8 on the jack may become damaged from this practice. A disadvantage is the poor transmission performance associated with this type of pair sequence. None of these pair schemes is cabling standard compliant.

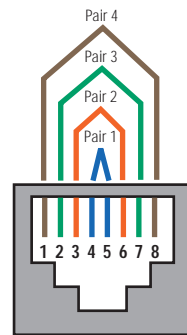

USOC 4-pair

Pair ID	PIN #
T1	5
R1	4
T2	3
R2	6
T3	2
R3	7
T4	1
R4	8

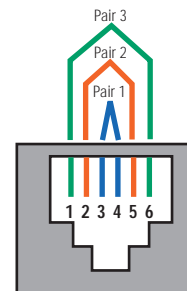

USOC 1-, 2- or 3-pair

Pair ID	PIN #
T1	4
R1	3
T2	2
R2	5
T3	1
R3	6

10BASE-T wiring specifies an 8-position jack but uses only two pairs. These are pairs two and three of T568A and T568B schemes.

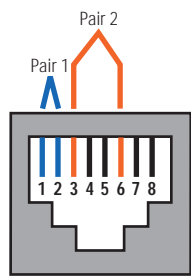

10BASE-T (802.3)

Pair ID	PIN #
T1	1
R1	2
T2	3
R2	6

Token Ring wiring uses either an 8-position or 6-position jack. The 8-position format is compatible with T568A, T568B, and USOC wiring schemes. The 6-position is compatible with 1- or 2-pair USOC wiring.

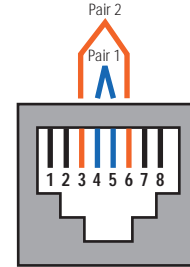

Token Ring (802.5)

Pair ID	PIN #
T1	5
R1	4
T2	3
R2	6

The MMJ is a unique wiring scheme for DEC® equipment.

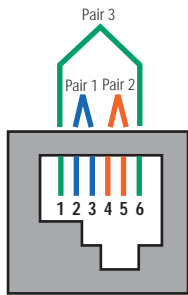

3-Pair MMJ

Pair ID	PIN #
T1	3
R1	2
T2	4
R2	5
T3	1
R3	6

ANSI X3T9.5 TP-PMD uses the two outer pairs of an 8-position jack. These positions are designated as pair 3 and pair 4 of the T568A wiring scheme. This wiring scheme is also used for ATM.

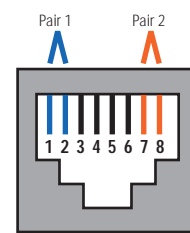

TP-PMD (X3T9.5) and ATM

Pair ID	PIN #
T1	1
R1	2
T2	7
R2	8

MODULAR PLUG PAIR CONFIGURATIONS

It is important that the pairing of wires in the modular plug match the pairs in the modular jack as well as the horizontal and backbone wiring. If they do not, the data being transmitted may be paired with incompatible signals.

Modular cords wired to the T568A color scheme on both ends are compatible with T568B systems and vice versa.



UTP Horizontal Cable (solid 24 AWG)

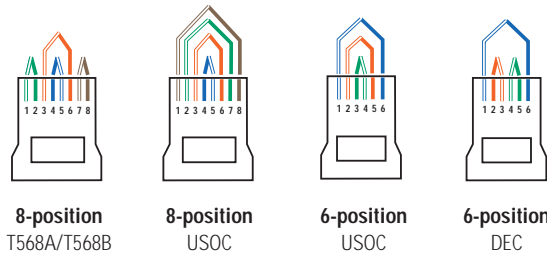

STRAIGHT-THROUGH OR REVERSED?

Modular cords are used for two basic applications. One application uses them for patching between modular patch panels. When used in this manner modular cords should always be wired "straight-through" (pin 1 to pin 1, pin 2 to pin 2, pin 3 to pin 3, etc.). The second major application uses modular cords to connect the workstation equipment (PC, phone, FAX, etc.) to the modular outlet. These modular cords may either be wired "straight-through" or "reversed" (pin 1 to pin 6, pin 2 to pin 5, pin 3 to pin 4, etc.) depending on the system manufacturer's specifications. This "reversed" wiring is typically used for voice systems. The following is a guide to determine what type of modular cord you have.

HOW TO READ A MODULAR CORD:

Align the plugs side-by-side with the contacts facing you and compare the wire colors from left to right. If the colors appear in the same order on both plugs, the cord is wired "straight-through". If the colors appear reversed on the second plug (from right to left), the cord is wired "reversed".



RECOMMENDED CABLING PRACTICES:

Do's:

- ✓ Use connecting hardware that is compatible with the installed cable.
- ✓ Terminate each horizontal cable on a dedicated telecommunications outlet.
- ✓ Locate the main cross-connect near the center of the building to limit cable distances.
- ✓ Maintain the twist of horizontal and backbone cable pairs up to the point of termination.
- ✓ Tie and dress horizontal cables neatly and with a minimum bend radius of 4 times the cable diameter.
- ✓ Place cabling at a sufficient distance from equipment that may generate high levels of electromagnetic interference.

Don'ts

- ✗ Do not use connecting hardware that is of a lower category than the cable being used.
- ✗ Do not create multiple appearances of the same cable at several distribution points (called bridged taps).
- ✗ Do not locate cross-connects where cable distances will exceed the maximum.
- ✗ Do not leave any wire pairs untwisted.
- ✗ Do not over-tighten cable ties, use staples, or make sharp bends with cables.
- ✗ Do not place cable near equipment that may generate high levels of electromagnetic interference.

UTP CONNECTOR TERMINATIONS:



- Pair twists shall be maintained as close as possible to the point of termination.
- Untwisting shall not exceed 25mm (1.0 in) for category 4 links and 13mm (0.5 in) for category 5 and category 5e links. Follow manufacturer guidelines for category 3 products, if no guidelines exist, then untwisting shall not exceed 75mm (3.0 in).
- Connecting hardware shall be installed to provide well-organized installation with cable management and in accordance with manufacturer's guidelines.
- Strip back only as much jacket as is required to terminate individual pairs.

APPLICATION-SPECIFIC PAIR ASSIGNMENTS FOR THE 100 OHM CABLING, ISO/IEC 8802:

Application	Pins 1-2	Pins 3-6	Pins 4-5	Pins 7-8
ISDN	Power	TX	RX	Power
Analogue Voice	—	—	TX/RX	—
802-3 (10BASE-T)	TX	RX	—	—
802-5 (Token Ring)	—	TX	RX	—
FDDI (TP-PMD)	TX	Optional ¹	Optional ¹	RX
ATM User Device	TX	Optional ¹	Optional ¹	RX
ATM Network Equip.	RX	Optional ¹	Optional ¹	TX
1000BASE-T	Bi ²	Bi ²	Bi ²	Bi ²
100BASE-VG (802.12)	Bi	Bi	Bi	Bi
100BASE-T4 (802.3u)	TX	RX	Bi	Bi
100BASE-TX (802.3u)	TX	RX	—	—

*Bi = bi-directional TX = Transmit RX = Receive

¹Optional terminations may be required by some manufacturers' active implementations.

²Under development by IEEE802.3ab

13.24

RECOMMENDED COLOR-CODING SCHEME:

Siemon Color #	Color Code	Description
01	black ■	No Termination Type Assigned
02	white □	1st Level Backbone (MC/IC or MC/TC Terminations)
03	red ■	Reserved for future use (formerly Key Telephone Sys.)
04	gray ■	Second Level Backbone (IC/TC Terminations)
05	yellow ■	Miscellaneous (Auxiliary, Security, Alarms, etc.)
06	blue ■	Horizontal Cable Terminations (a.k.a. Station Cable)
07	green ■	Network Connections (customer side of demarc)
08	purple ■	Common Equipment (PBX, Host, LANs, Muxes)
09	orange ■	Demarcation Point (Central Office Terminations)
60	brown ■	Interbuilding Backbone (Campus Cable Terminations)

UTP CABLING INSTALLATION PRACTICES

- To avoid stretching, pulling tension should not exceed 110N (25 lbf) for 4-pair cables.
- Installed bend radii shall not exceed:
 - 4 times the cable diameter for horizontal UTP cables.
 - 10 times the cable diameter for multi-pair backbone UTP cables.
- Avoid cable stress, as caused by:
 - cable twist during pulling or installation
 - tension in suspended cable runs
 - tightly cinched cable ties or staples
 - tight bend radii
- Horizontal cables should be used with connecting hardware and patch cords (or jumpers) of the same performance category or higher.
- Important Note: Installed UTP cabling shall be classified by the least performing component in the link.

ANSI/TIA/EIA-569-A

Commercial Building Standard for Telecommunications Pathways and Spaces

The Telecommunications Industry Association (TIA) TR41.8.3 Working Group on Telecommunications Pathways & Spaces published the ANSI/TIA/EIA-569-A ('569-A) Standard in 1998.

Following are highlights of the '569-A Standard:

Purpose

- Standardize design and construction practices.
- Provides a telecommunications support system that is adaptable to change during the life of the facility.

Scope

- Pathways and spaces in which telecommunications media are placed and terminated.
- Telecommunications pathways and spaces within and between buildings.
- Commercial building design for both single and multi-tenant buildings.

Elements

- Horizontal
- Backbone
- Work Area
- Telecommunications Closet
- Equipment Room
- Main Terminal Space
- Entrance Facility

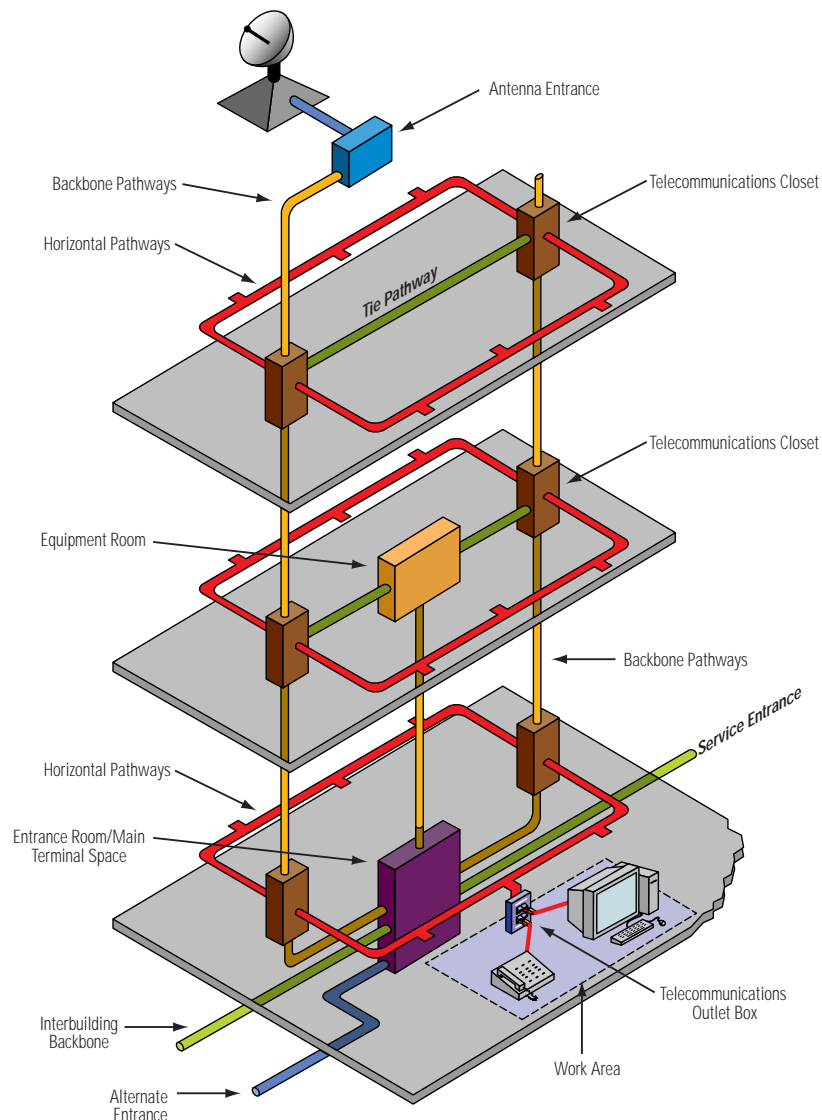

HORIZONTAL

Pathways from telecommunications closet to work area.

Includes:

Pathway Types:

- Underfloor - Network of raceways embedded in concrete consisting of distribution and header ducts, trenches, and cellular systems.
- Access Floor - Raised modular floor tile supported by pedestals, with or without lateral bracing or stringers.
- Conduit - Metallic and nonmetallic tubing of rigid or flexible construction permitted by applicable electrical code.
- Tray & Wireway - Prefabricated rigid structures for pulling or placing cable.
- Ceiling - Open environment above accessible ceiling tiles and frame work.
- Perimeter- Surface, recessed, molding, and multichannel raceway systems for wall mounting around rooms or along hallways.

Space Types:

- Pull Boxes - Used in conjunction with conduit pathway systems to assist in the fishing and pulling of cable.
- Splice Boxes - A box, located in a pathway run, intended to hold a cable splice.
- Outlet Boxes - Device for mounting faceplates, housing terminated outlet/connectors, or transition devices.

Design Considerations:

- Grounded per code and ANSI/TIA/EIA-607 ('607)
- Designed to handle recognized media as specified in ANSI/TIA/EIA-568-A ['568-A]
- Not allowed in elevator shafts
- Accommodate seismic zone requirements
- Installed in dry locations

BACKBONE

Pathways routed from closet-to-closet.

Building Backbone Types:

- Ceiling
- Conduit
- Sleeves - An opening, usually circular, through the wall, ceiling, or floor.
- Slots - An opening, usually rectangular, through the wall, ceiling, or floor.
- Trays

Typically the most convenient and cost effective backbone pathway design in multi-story buildings, is to have stacked closets located one above the other, connected by sleeves or slots.

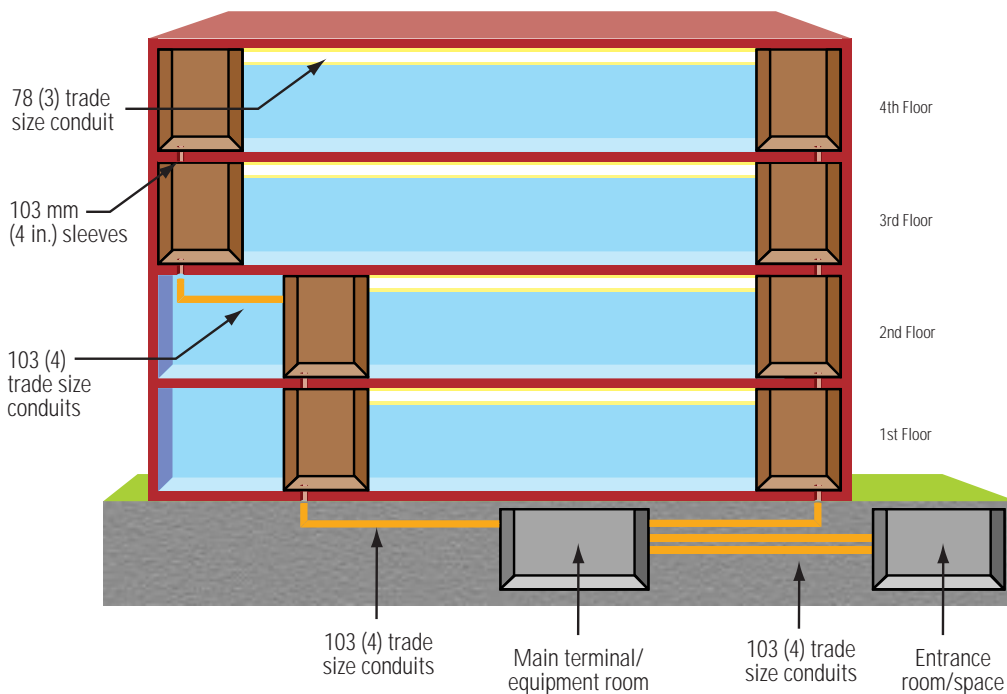

Design Considerations:

- Grounded per code and '607
- Accommodate seismic zone requirements
- Water should not penetrate the pathway system
- Tray, conduits, sleeves, slots penetrate closets minimum 25mm (1 in.)
- Designed to handle all recognized media (as specified in '568-A)
- Integrity of all fire stop assemblies shall be maintained

WORK AREA

Primary location where the building occupants interact with dedicated telecommunications equipment.

Design Considerations:

- At least one telecommunication outlet box location shall be planned for each work area.
- This location should be coordinated with the furniture plan. A power outlet should be nearby.
- Control center, attendant, and reception areas shall have direct and independent pathways to the serving telecommunications closet.
- Furniture System Design:
 - Cable access via walls, columns, ceilings, or floors. Fittings that transition between building and furniture pathways require special planning.
 - Furniture pathway fill capacity is effectively reduced by furniture corners, and connectors mounted within the furniture pathway systems.
 - Furniture pathways bend radius shall not force the installed cable to a bend radius of less than 25 mm (1 in.).
 - Furniture spaces designed to house slack storage, consolidation points, or multi-user telecommunications outlet assemblies shall provide space for strain relieving, terminating, and storing slack for the horizontal cables.
 - Slack storage and furniture pathway fill, shall not affect the bend radius and termination of the cable to the connector.
 - Furniture pathway openings shall comply with either of two sizes:
 - Standard NEMA opening (NEMA OS 1 [Ref D.14], WD-6 [Ref D.15])
 - Alternate opening:

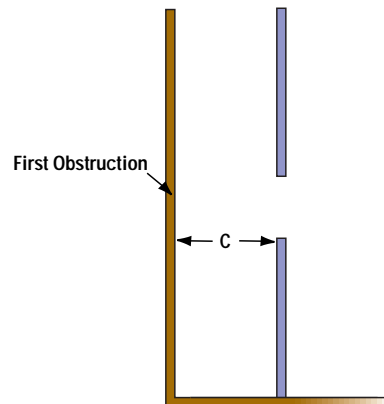
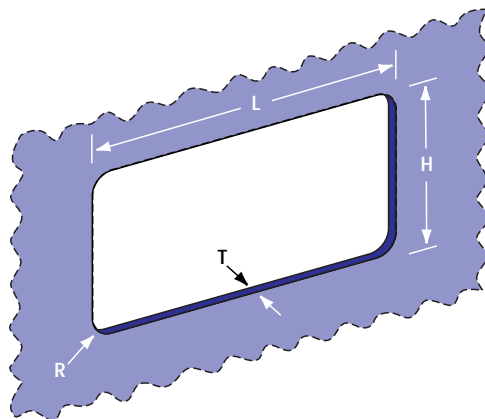

	Dimension	Tolerance
L (length)	.68.8mm (2.71 in.)	.1.02mm (0.040 in.)
H (height)	.35.1mm (1.38 in.)	.0.90mm (0.035 in.)
T (depth)	.1.40mm (0.055 in.)	.0.64mm (0.025 in.)
R (corner radius)	.4.06mm (0.160 in.) max.	—
C (distance to 1st obstruction)	.30.5mm (1.2 in.) min.	—

- Power/telecommunication separation requirements is governed by applicable electrical code for safety. Minimum separation requirements of Article 800-52 of ANSI/NFPA 70 (Ref D.3) shall be applied.

TELECOMMUNICATIONS CLOSETS

Recognized location of the common access point for backbone and horizontal pathways.

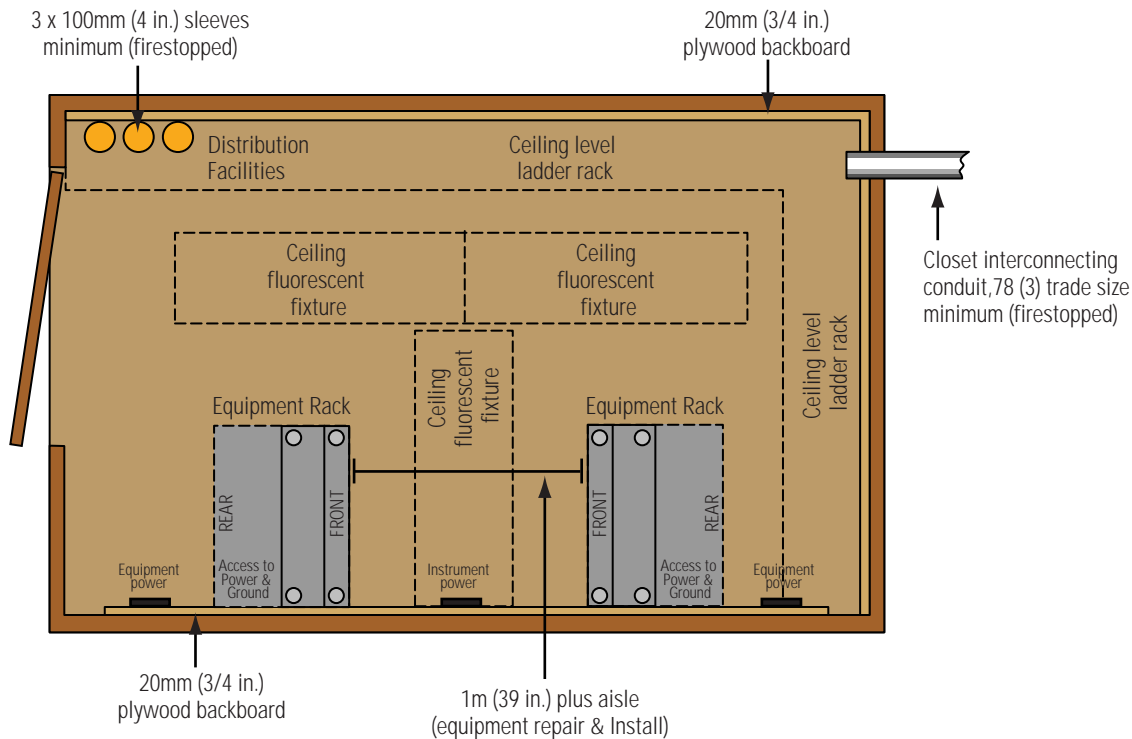

13.28

Design:

- Dedicated to telecommunications function.
- Equipment not related to telecommunications shall not be installed, pass through or enter the telecommunications closet.
- Multiple closets on the same floor shall be interconnected by a minimum of one (78 (3) trade size) conduit, or equivalent pathway.
- Minimum floor loading 2.4 kPa (50 lbf/ft²).

Design Considerations:

- Minimum one closet per floor to house telecommunications equipment/cable terminations and associated cross-connect cable and wire.
- Located near the center of the area being served.
- Horizontal pathways shall terminate in the telecommunications closet on the same floor as the area served.
- Accommodate seismic zone requirements.

- Two walls should have 20mm (0.75 in.) A-C plywood 2.4m (8 ft.) high.
- Lighting shall be a minimum of 500 lx (50 foot candles) and mounted 2.6m (8.5 ft.) above floor.
- False ceilings shall not be provided.
- Minimum door size 910mm (36 in.) wide and 2000mm (80 in.) high without sill, hinged to open outwards, or slide side-to-side or removable, and fitted with a lock.
- Minimum of two dedicated 120V 20A nominal, non-switched, AC duplex electrical outlet receptacles, each on separate branch circuits.
- Additional convenience duplex outlets placed at 1.8m (6 ft.) intervals around perimeter, 150mm (6 in.) above floor.
- Access to the telecommunications grounding system as specified by ANSI/TIA/EIA-607.
- HVAC requirements to maintain temperature the same as adjacent office area. A positive pressure shall be maintained with a minimum of one air change per hour or per code.

EQUIPMENT ROOM

A centralized space for telecommunications equipment that serves specific occupants of the building.

Any or all of the functions of a telecommunications closet or entrance facility may alternately be provided by an equipment room.

Location

- Site locations should allow for expansion.
- Accessible to the delivery of large equipment.
- Not located below water level.
- Away from sources of EMI.
- Safeguards against excessive vibration.
- Sizing shall include projected future as well as present requirement.
- Equipment not related to the support of the equipment room shall not be installed in, pass through, or enter the equipment room.

Design Considerations

- Minimum clear height of 2.4m (8 ft.) without obstruction.

- Protected from contaminants and pollutants.
- Access to backbone pathways.
- HVAC provided on a 24 hours-per-day, 365 days-per-year basis.
- Temperature and humidity controlled range 18° C (64° F) to 24° C (75° F) with 30% to 55% relative humidity measured 1.5m (5 ft.) above floor level.
- Separate power supply circuit shall be provided and terminated in its own electrical panel.
- Minimum lighting 500 lx (50 foot candles). Switch location shall be near entrance door to room.
- Minimum door same as telecommunications closet. Double doors without center post or sill is recommended.
- Access to ground per ANSI/TIA/EIA-607.

MAIN TERMINAL SPACE

Centralized space that houses the main cross-connect. Commonly used as a separate space in multi-tenant buildings to serve all tenants.

- Location considerations are as specified for equipment room.
- Provisioning area as specified for telecommunications closets except power is reduced to convenience receptacles.

ENTRANCE FACILITY

Consists of the telecommunications service entrance to the building and backbone pathways between buildings.

Location

- Providers of all telecommunications services shall be contacted to establish requirements.
- Location of other utilities shall be considered in locating the entrance facility.
- Alternate entrance facility should be provided where security, continuity or other special needs exist.
- Equipment not related to the support of the entrance facility should not be installed in, pass through, or enter the telecommunications entrance facility.
- Dry location not subject to flooding and close as practicable to building entrance point and electrical service room.

Design Considerations

- Accommodate the applicable seismic zone requirements.
- A service entrance pathway shall be provided via one of the following entrance types: Underground, Buried, Aerial, Tunnel.
- Minimum one wall should be covered with rigidly fixed 20mm (0.75 in.) A-C plywood.
- Minimum lighting same as telecommunication closet.
- False ceilings shall not be provided.
- Minimum door same as telecommunications closet.
- Electrical power same as telecommunications closet. No convenience receptacles mentioned.
- Grounding same as telecommunications closet.

MISCELLANEOUS

- Fire stopping per applicable code
- Horizontal pathway separation from Electromagnetic interference (EMI) sources:
 - Separation between telecommunications and power cables (Article 800.52 of ANSI/NFPA 70)
 - Building protected from lightning (ANSI/NFPA 780 (Ref D.4)
 - Surge protection (Article 280 of ANSI/NFPA 70 and 9.11 of ANSI/IEEE 1100 [Ref D.1])
 - Grounding (ANSI/TIA/EIA-607)
 - Corrected faulty wiring (Section 7.5 of ANSI/IEEE 1100)
- Reducing noise coupling:
 - Increase separation from noise sources
 - Electrical branch circuit line, neutral, and grounding conductors should be maintained close together
 - Use of surge protectors in branch circuits
 - Use fully enclosed grounded metallic raceway or locate cabling near grounded metallic surface